

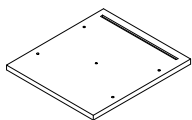

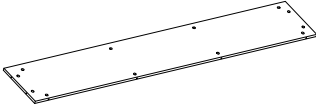







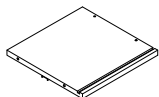
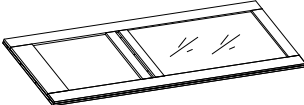

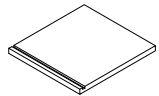
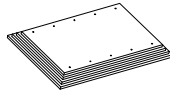
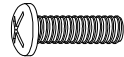
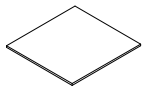
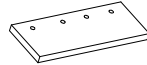
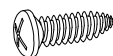
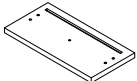
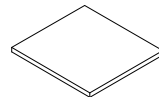
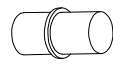

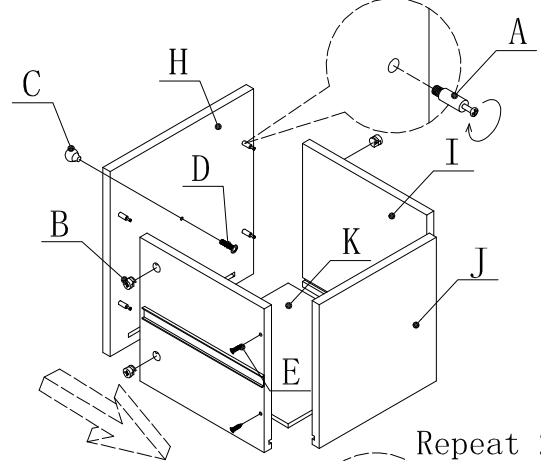
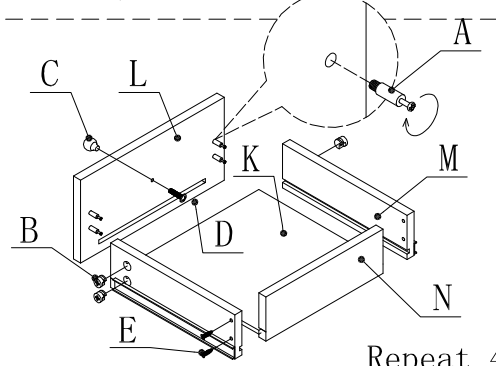

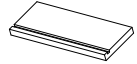
	Ø7*35	88	A		295*335*15	2	H		1900*300*15	1	U
	Ø15*12	88	B		300*200*15	4	I		1900*760*30	2	V
		8	C		245*200*15	2	J			2	W
	M4*20	8	D		254*294*5	6	K		600*215*25	2	X
	M4*35	24	E		295*150*15	4	L		297*358*15	4	Y
		16	F		300*80*15	8	M	<p>1.</p>  <p>Repeat 2 times</p> <hr/> <p>2.</p>  <p>Repeat 4 times</p>			
		2	G		245*80*15	4	N				
		2	G1		295*100*15	2	O				
		2	G2		275*300*15	2	P				
		6	G3		300*100*15	2	Q				
	M4*16	16	G4		300*340*15	2	R				
		4	G5		300*410*15	2	S				
					300*355*15	2	T				

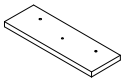
3. Repeat 2 times

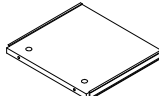

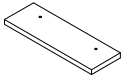
4. Repeat 2 times

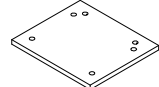

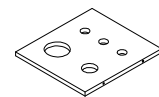
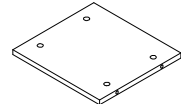
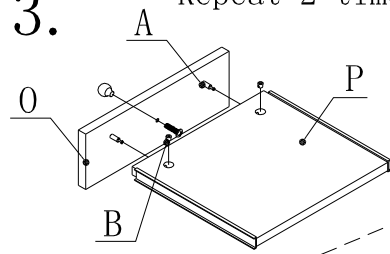
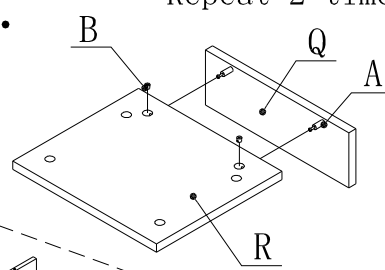
8.

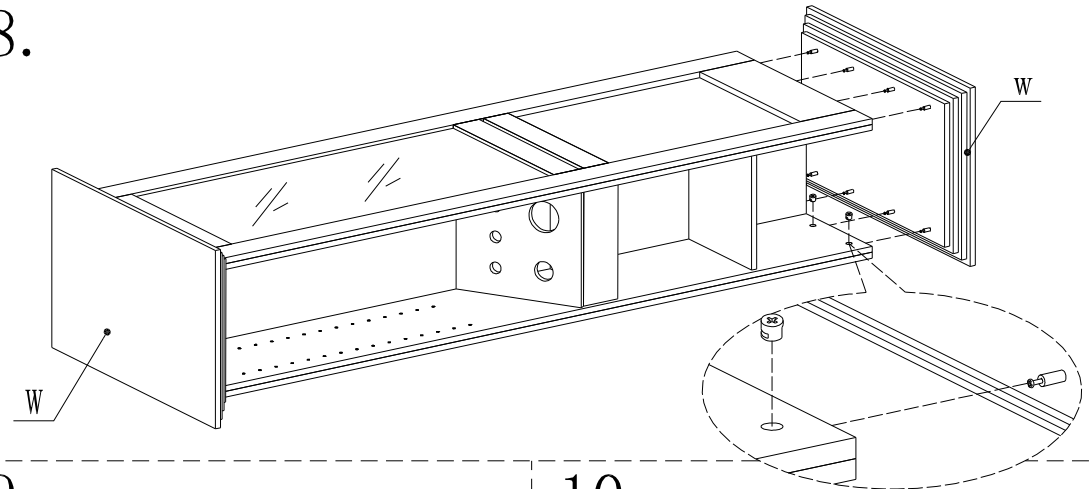

5.

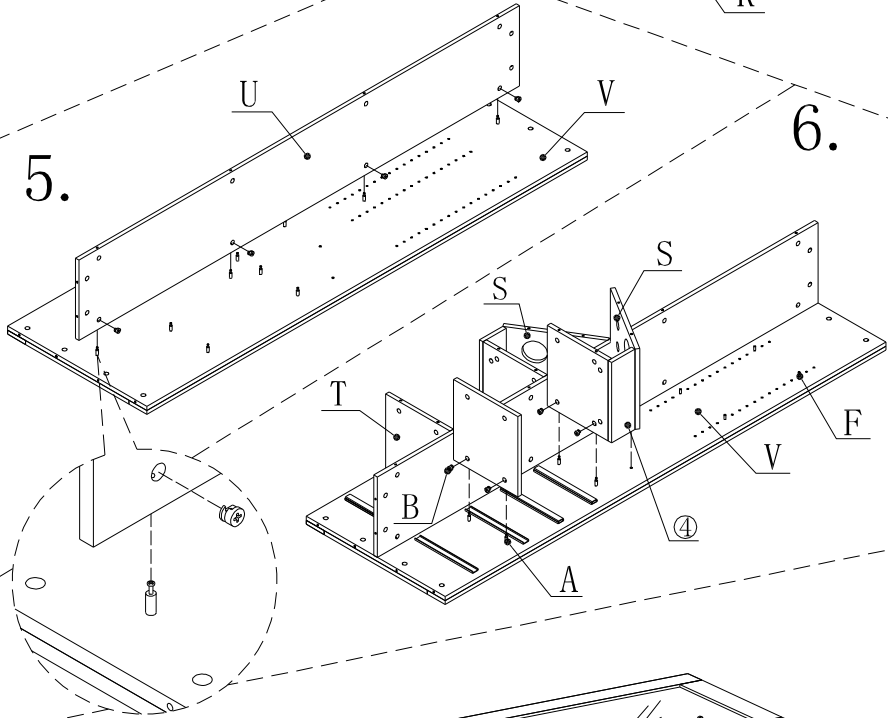

6.

9.

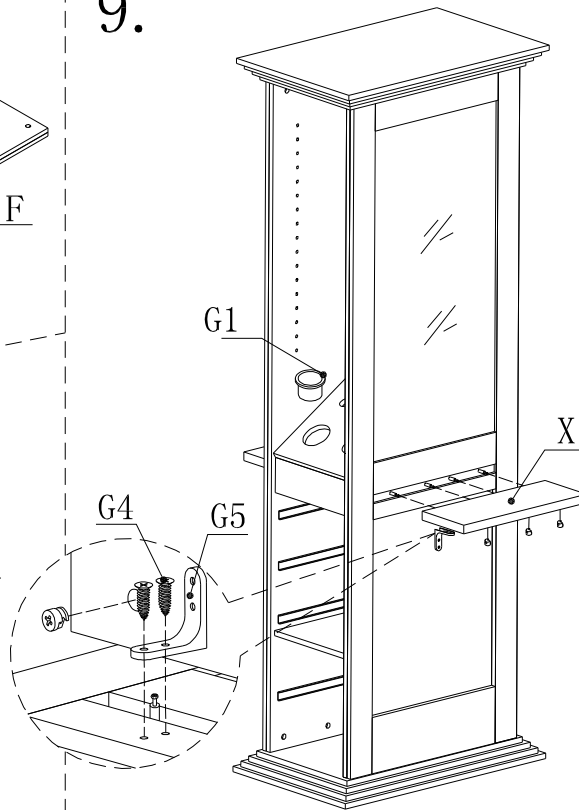

10.

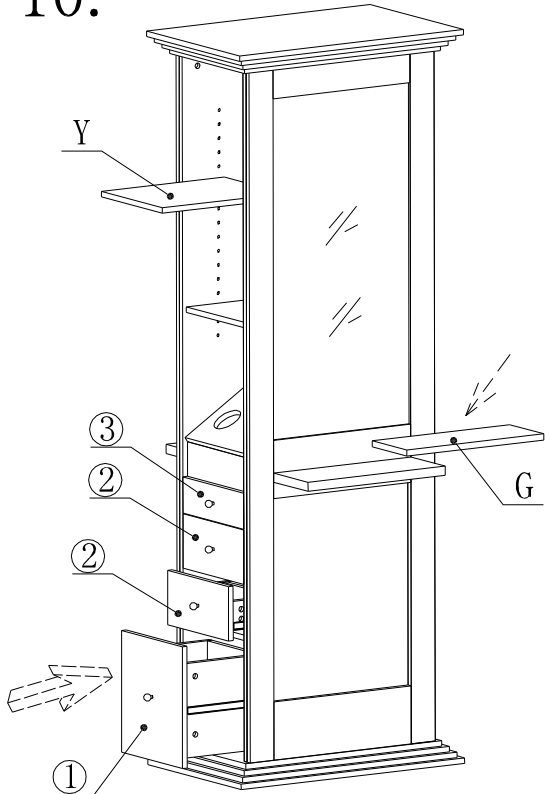

7.

